

X1TM_S

SEG DISPLAY

Universal Set-Up Instructions

Set-up applies to 2x2, 1x3, 2x3, 3x3 and 4x3 Frames

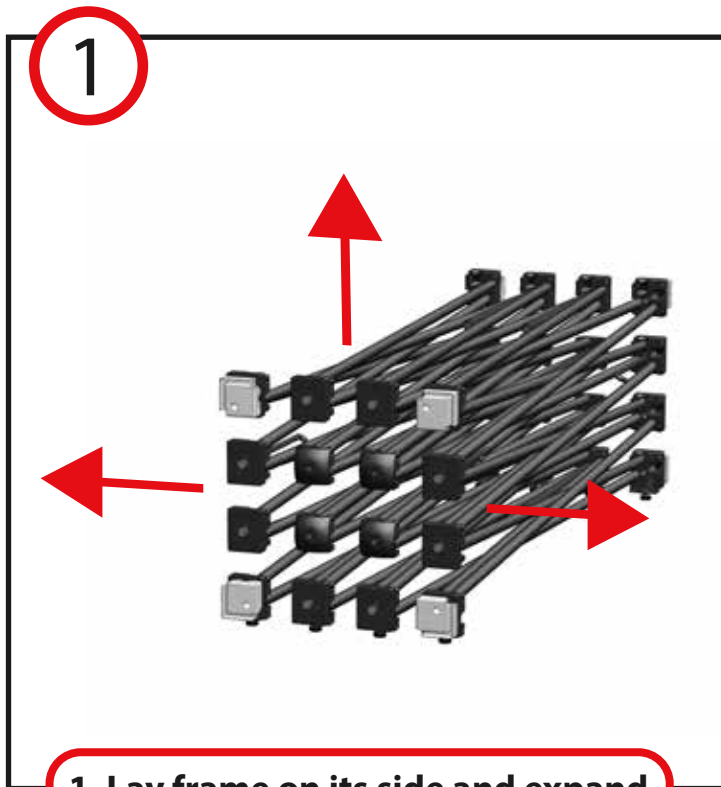

1. Lay frame on its side and expand until magnets snap into place.

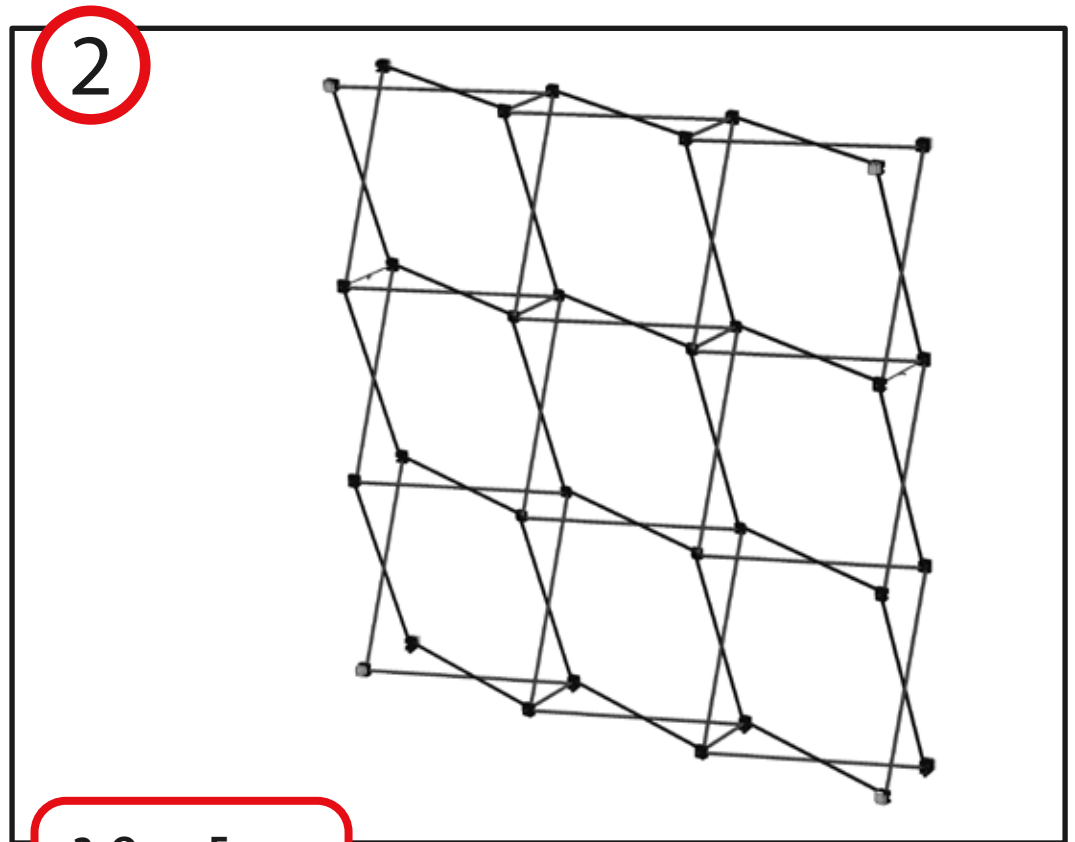

2. Open Frame

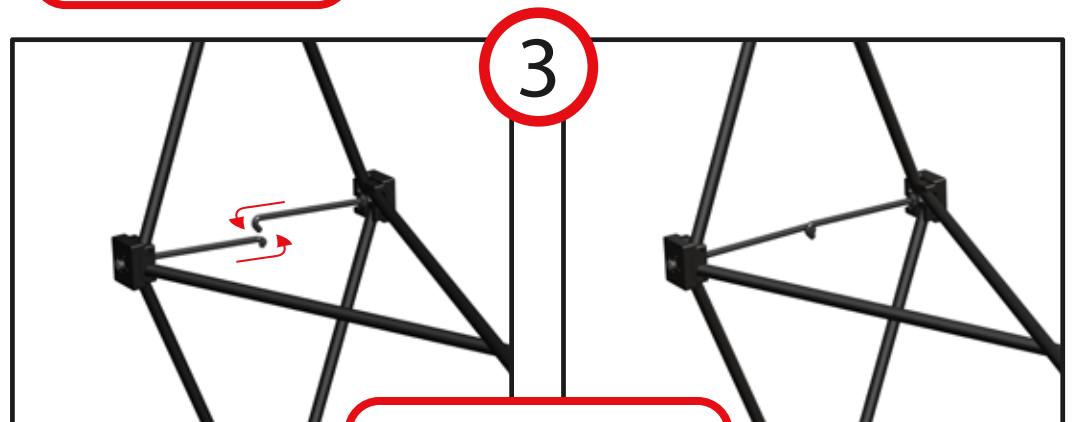

3. Connect J hooks

4



3 quad channel bar open connections

4. Remove bungee channel bars from the channel bar bag. Unfold each channel bar and slide each bar together creating a rigid channel bar.

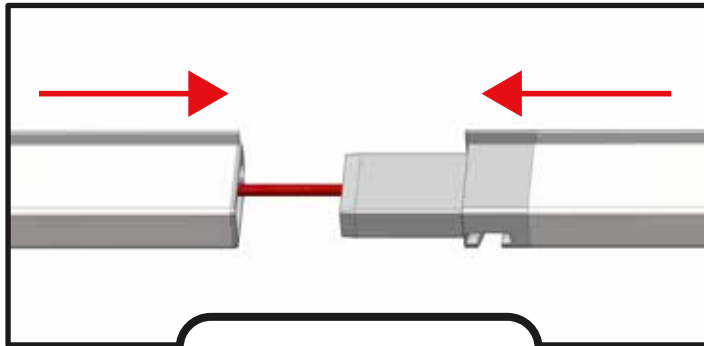

Open Connection

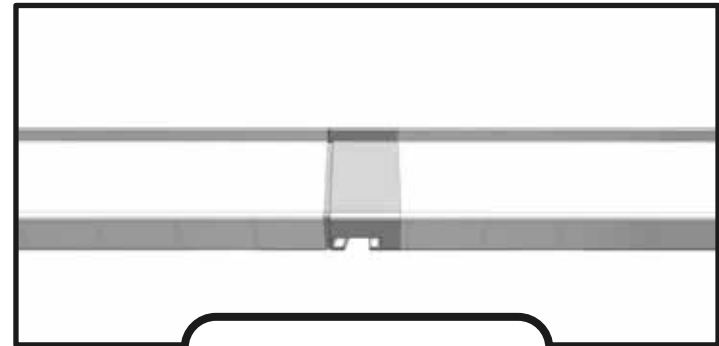

Closed Connection



Assembled 3 quad channel bar

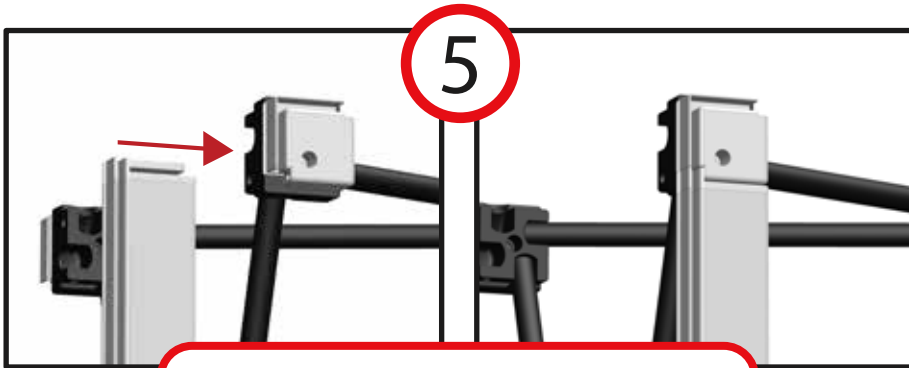

5. Slide channel bar end into the corresponding slot of the corner hub. Push together until tight.

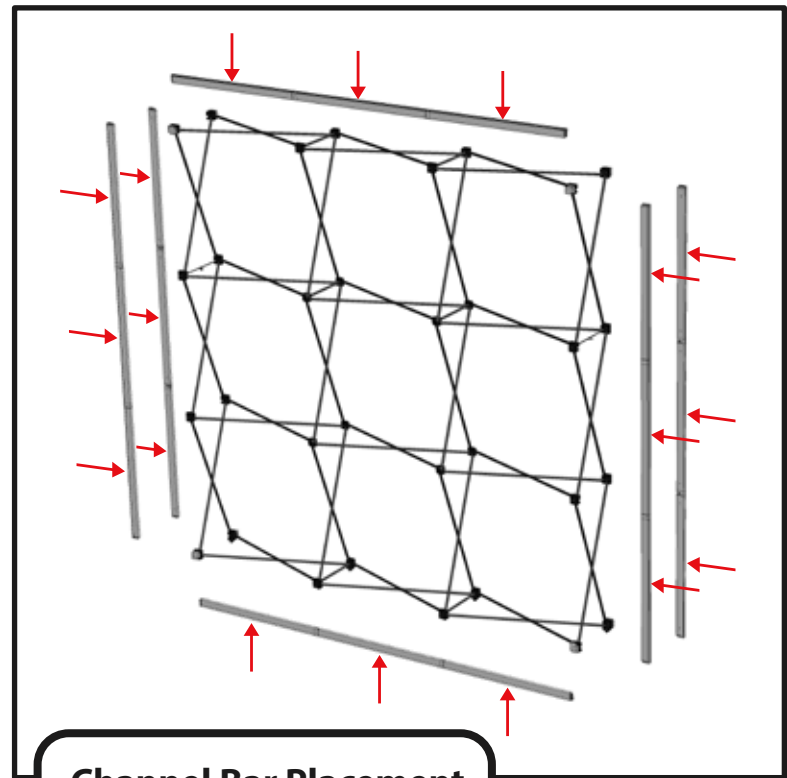

Channel Bar Placement

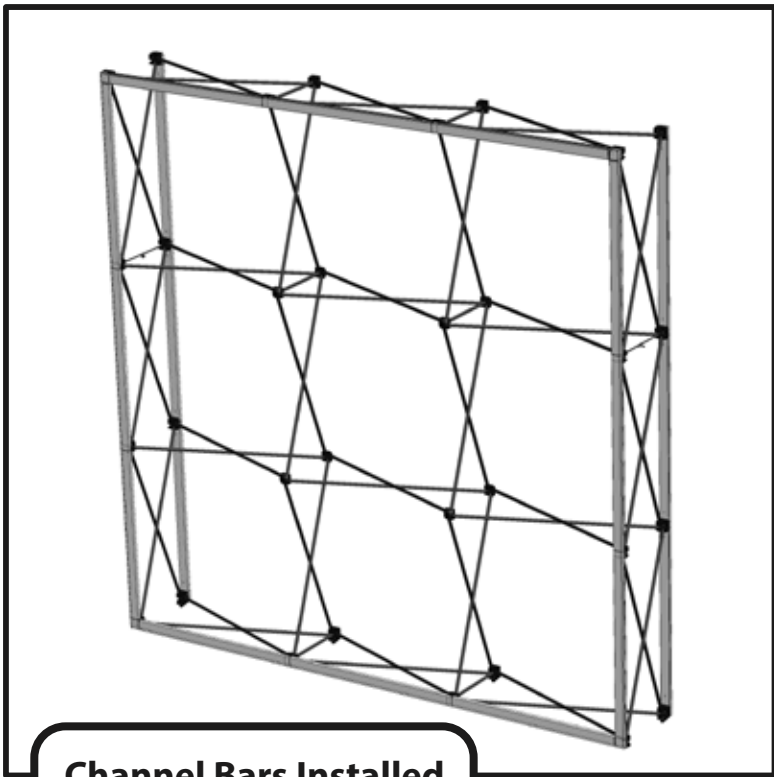

Channel Bars Installed

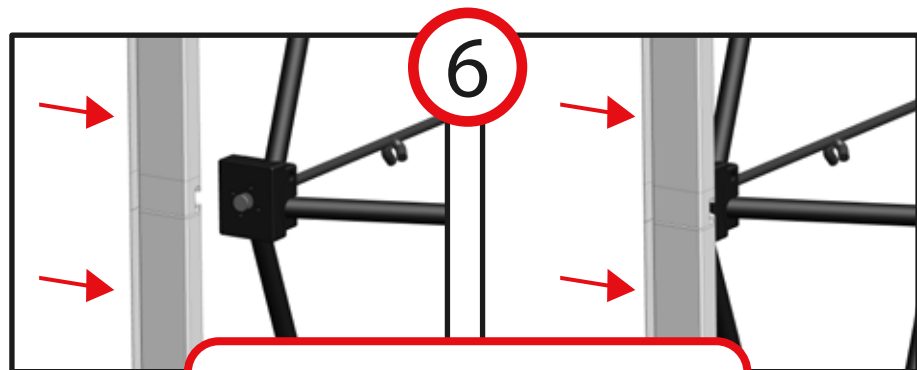

6. Slide the middle channel bar hub connector over the corresponding post of the frame hub. Push together until tight.

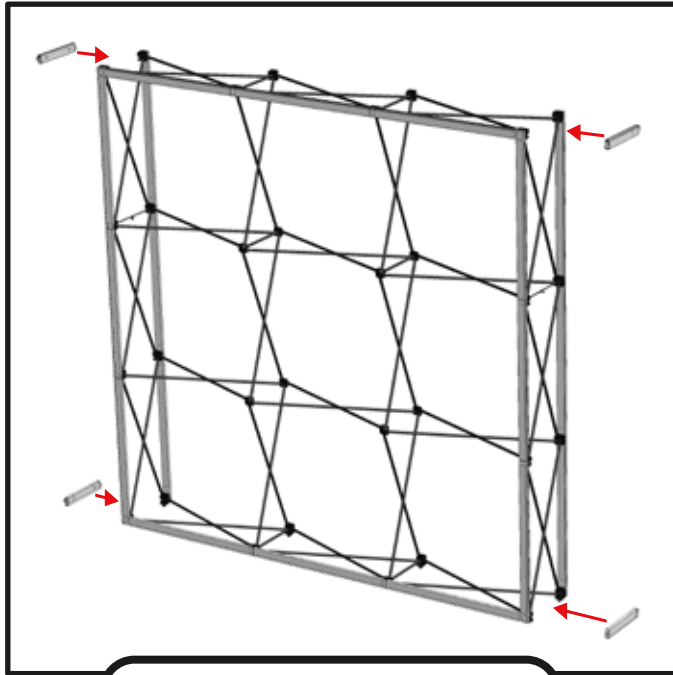

Endcap Bar Placement

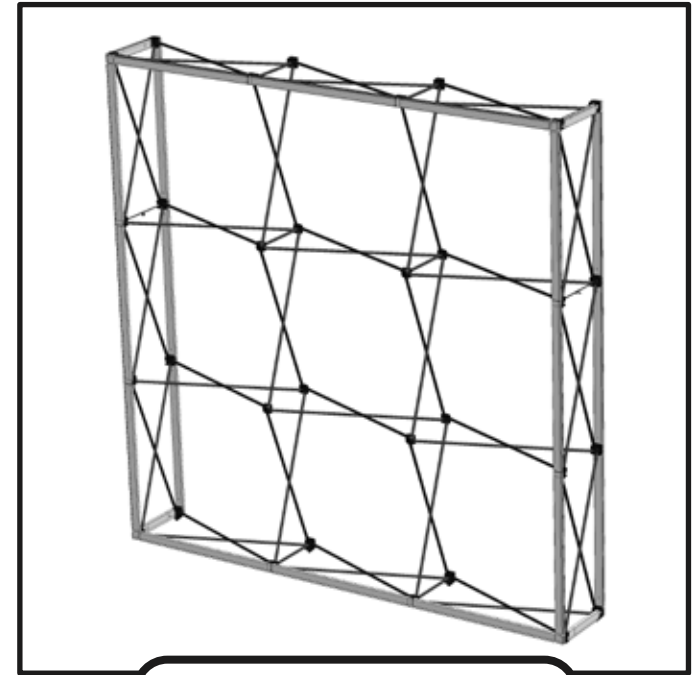
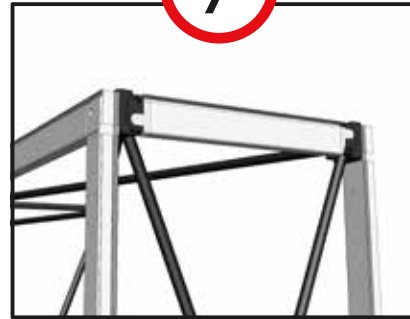
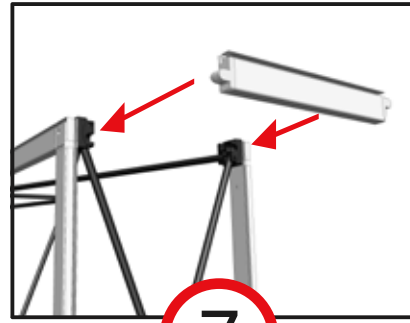

Endcap Bars Installed

7. Locate the endcap channel bars. Align the endcap bar making sure the SEG groove is facing the exterior of the frame. Then slide the channel bar ends into the corresponding grooves on the endcaps of the frame as shown above.

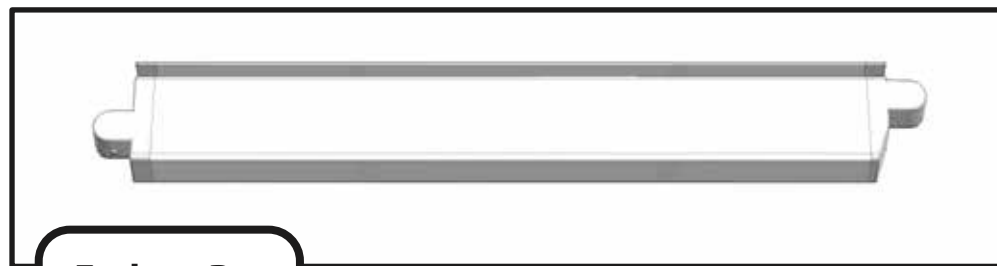

Endcap Bar

X1[™]_S

SEG DISPLAY

3x3 Standard SEG Graphic Installation Instructions

Pro Tip: When installing the SEG silicone into the SEG groove it is important to press the graphic into place to achieve a proper fit.

**Sliding the silicone into place will stretch the silicone and graphic.*

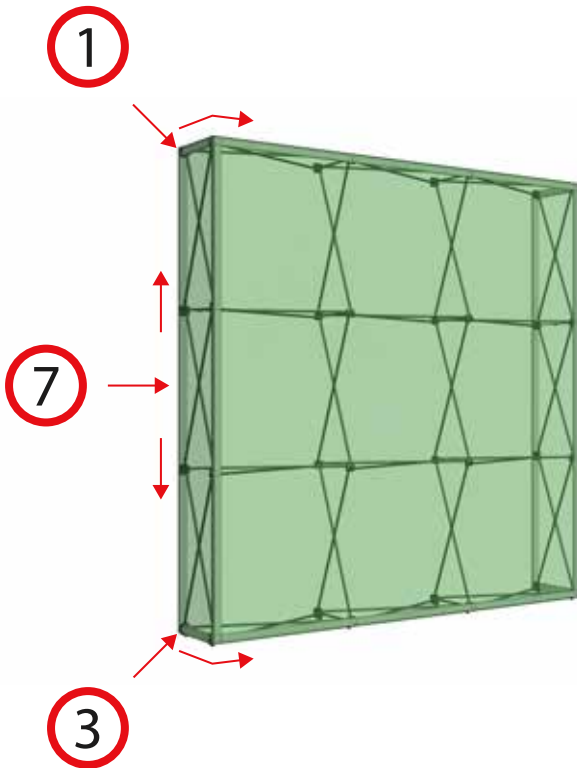
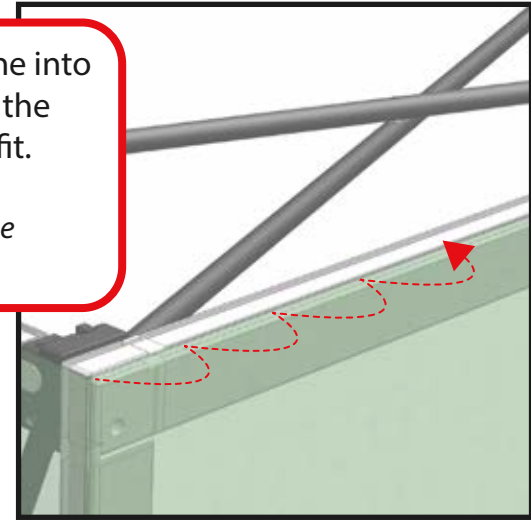

Left Side

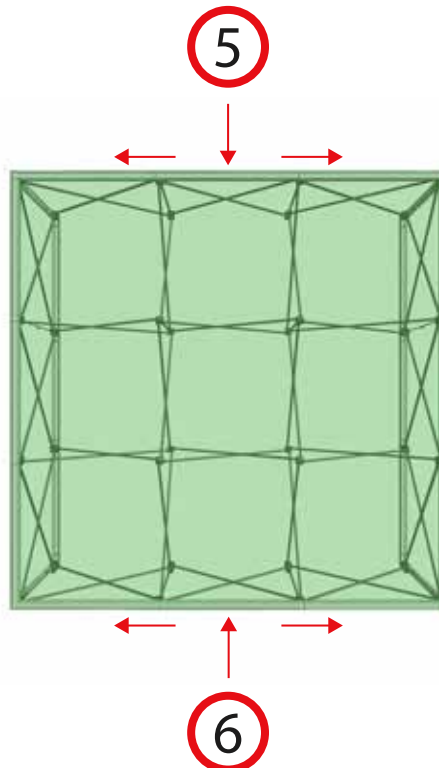

Front

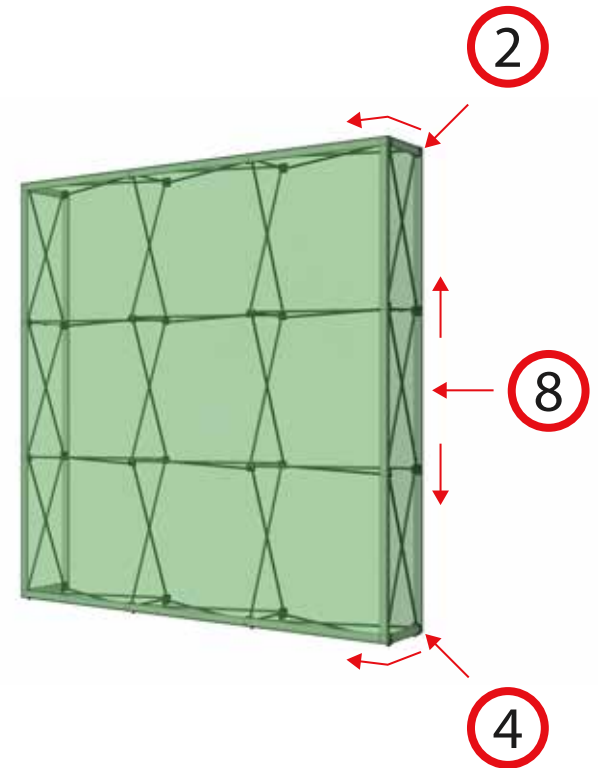

Right Side

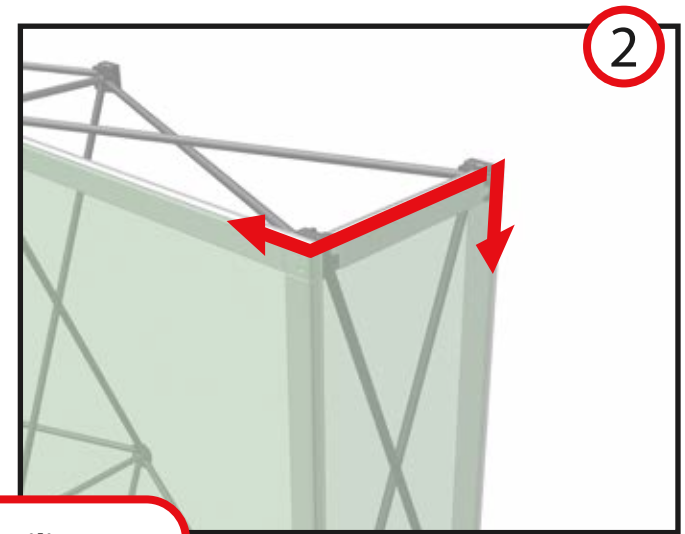
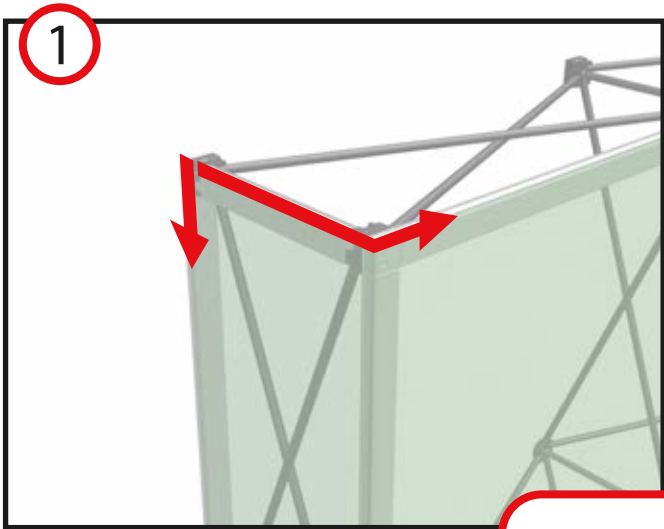

1-4. Starting in the top left corner, insert the silicone edge of the graphic into the side of the left rear channel bar and press into the groove about 6 in from the corner to secure the graphic in place. While supporting the graphic in your right hand press the silicone into the groove across the endcap channel bar and around to the front of the frame another in. While supporting the graphic move to the right side of the frame and repeat. Do this for all four corners.

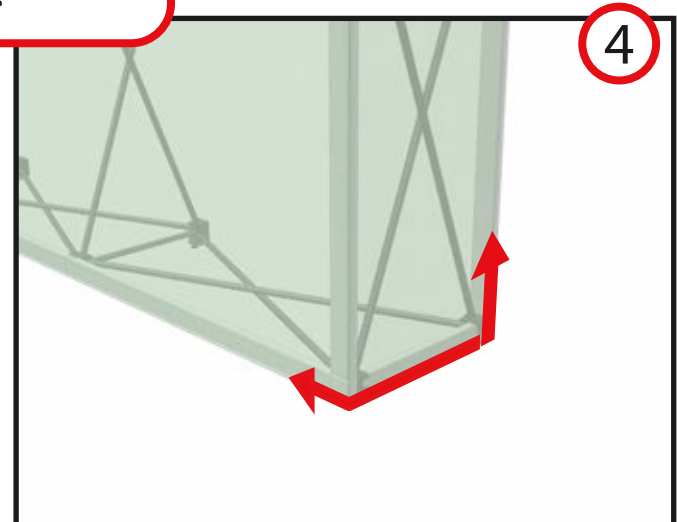
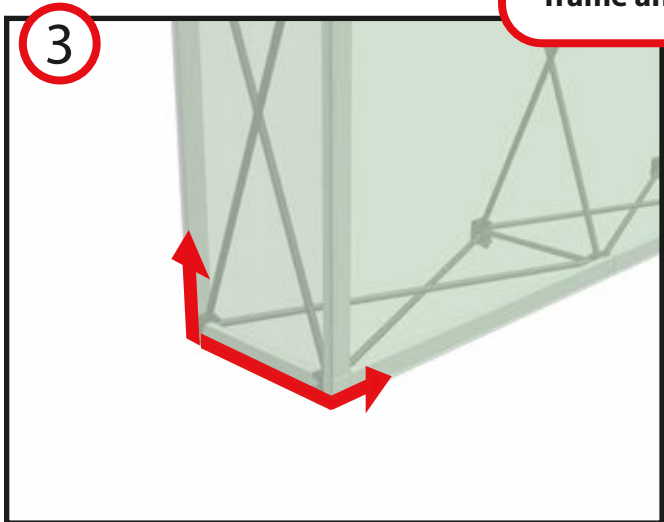

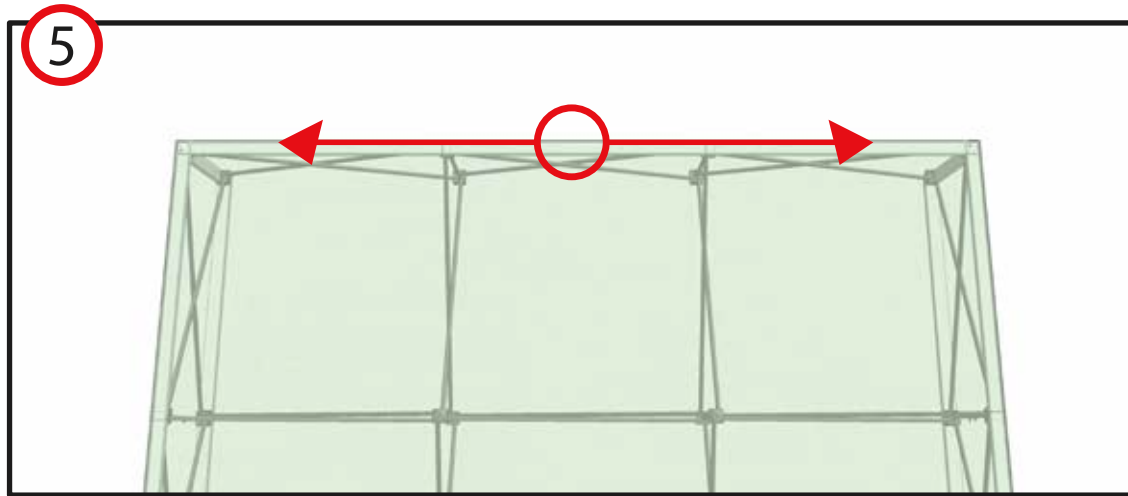

5-6. After all four corners are installed move to the center of the top of the graphic. Press the silicone into the SEG groove pressing the silicone into the groove alternating sides until the top of the graphic is installed. Repeat for the bottom of the graphic.

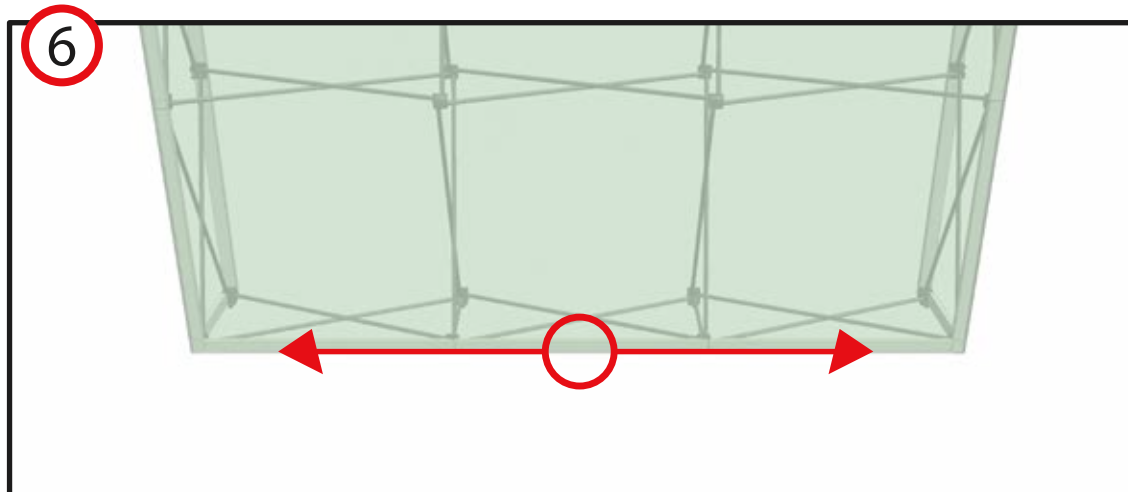

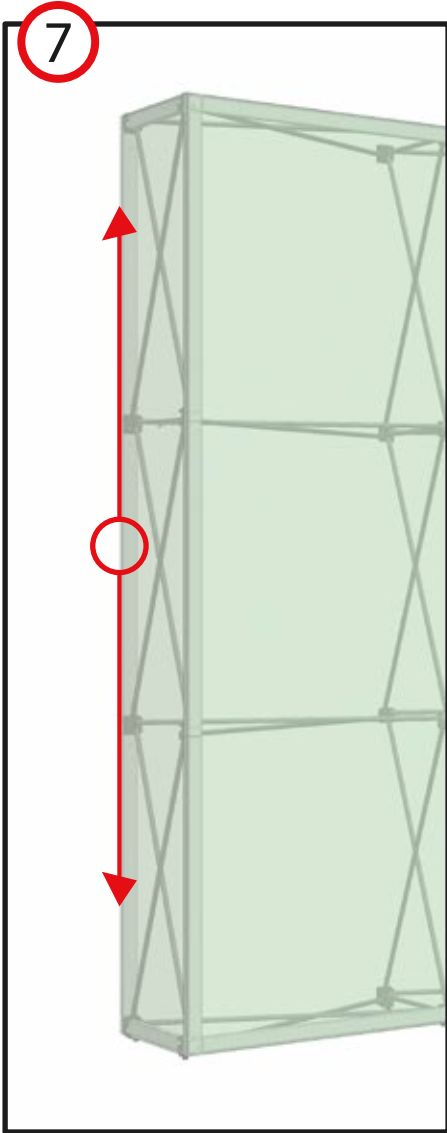

7-8. Move to the center of the left endcap and press the silicone into the SEG groove pressing the silicone into the groove alternating ether side of center until the left endcap graphic is installed. Repeat for the right endcap.

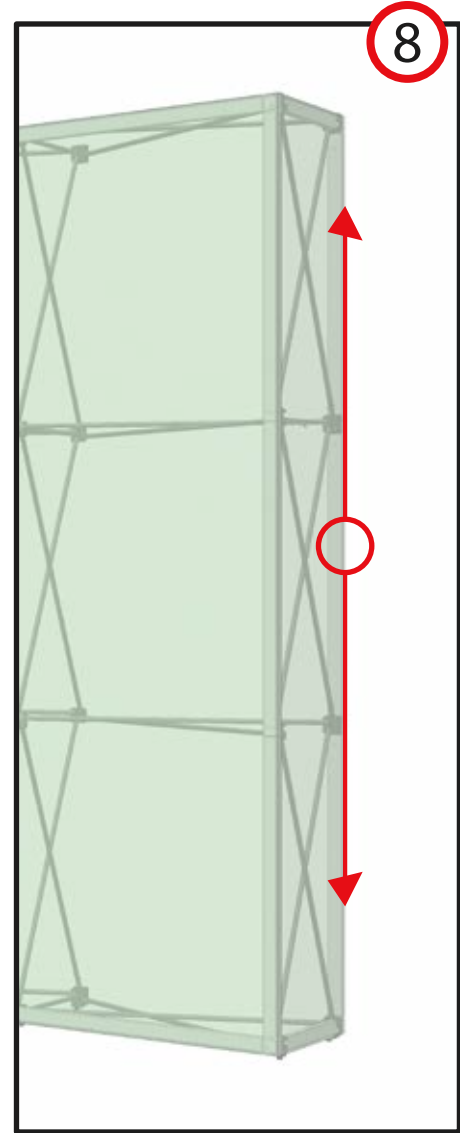

Display Dimensions
X1s Standard 3x3

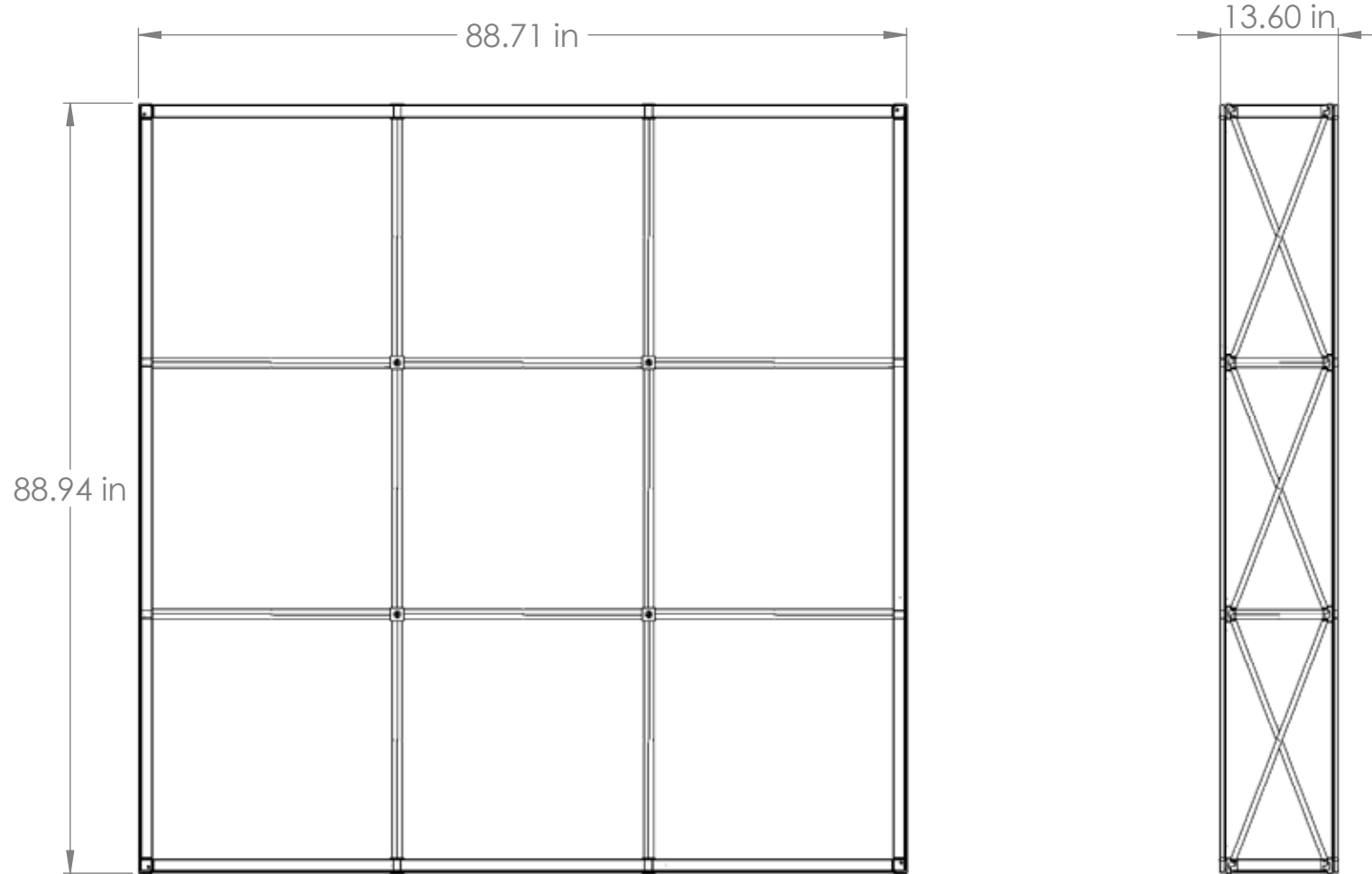

Radiance Lighting Set-Up

- 1) After frame is assembled, position light mounting brackets into place on the bottom frame quad scissors.

Note: the brackets are notched specifically to create a level platform for light placement and may need to be rotated to fit different frame systems.

- 2) Place Radiance lights into the mounting brackets and connect the wires and power supply.

Note: certain frame sizes will have multiple power supplies.

