

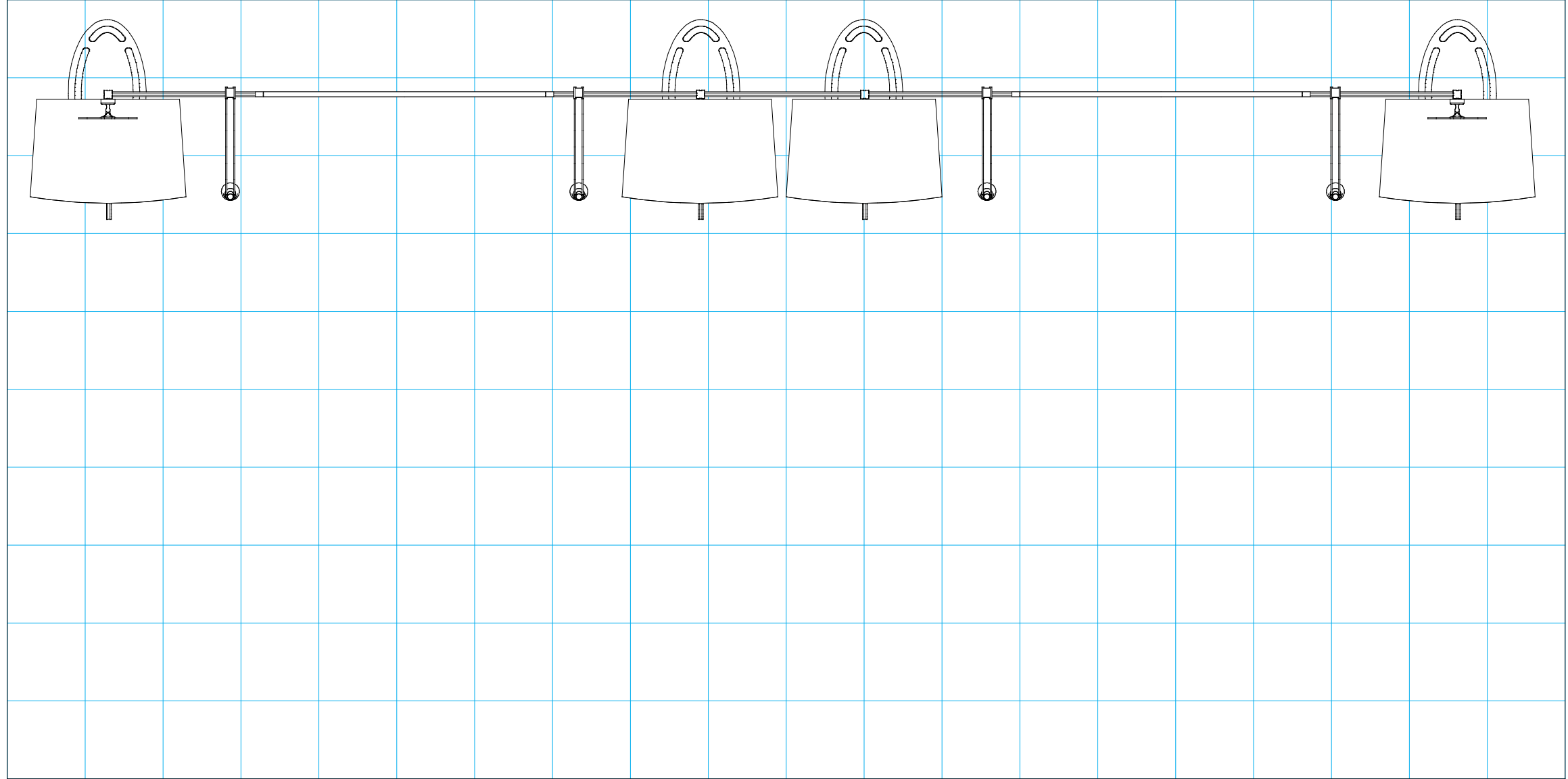

# SETUP INSTRUCTIONS



 = 1 sq foot

## General Setup Instructions

- Read entire setup instruction manual prior to unpacking parts and pieces.
- The setup instructions are created specifically for this configuration.
- Setup instructions are laid out sequentially in steps, including exploded views with detailed explanation for assembly.

## Cleaning & Packing

- For Cleaning Metal, Plex, & Laminate Parts: Use a **MILD NON-ABRASIVE** cleanser and soft cloth/paper towel to clean all surfaces.
- Keep exhibit components away from heat and prolonged sun exposure. **Heat and UV exposure will warp and fade components.**
- Retain all provided Packing Materials. All provided packing materials are for ease of repacking & component protection.

## Disassembly

- For loss prevention, tighten all set screws and locks during disassembly.



Hex Tool - Essential for Assembly

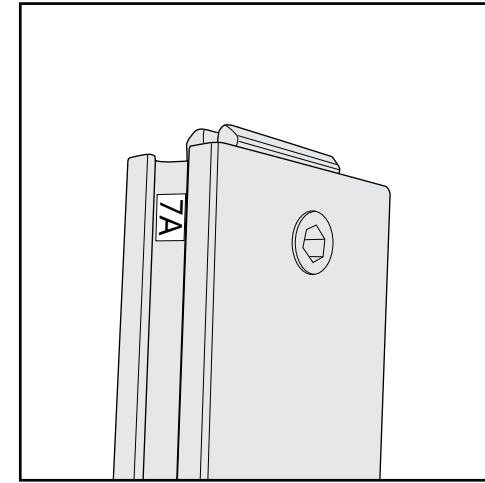

Part Identification - Numbering



Spline Connection



Base Plate & Extrusion Connection



Extrusion & Lock Connection



Engaged Lock



# WARNING



DO NOT USE POWER TOOLS



LADDERS OR LIFTS  
MAY BE REQUIRED



ALL CONNECTIONS MUST  
BE TIGHTLY SECURED



1) Mounting plate & wing nuts, in packed position.

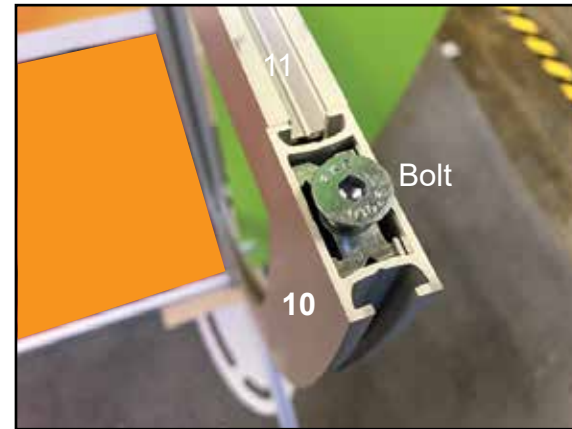

2) Mounting plate bolt in, packed position.

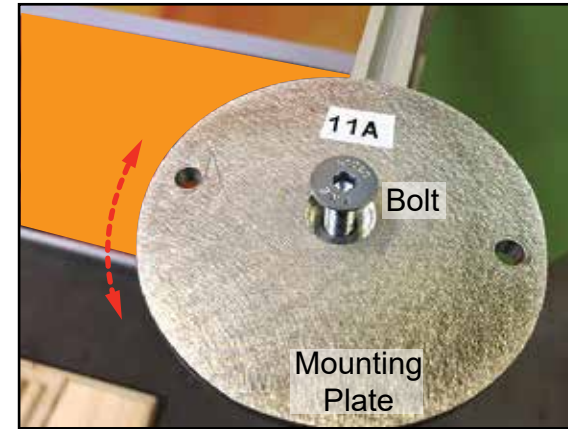

3) Place mounting plate onto [10] then tighten bolt, part way, allowing some rotation for final positioning.

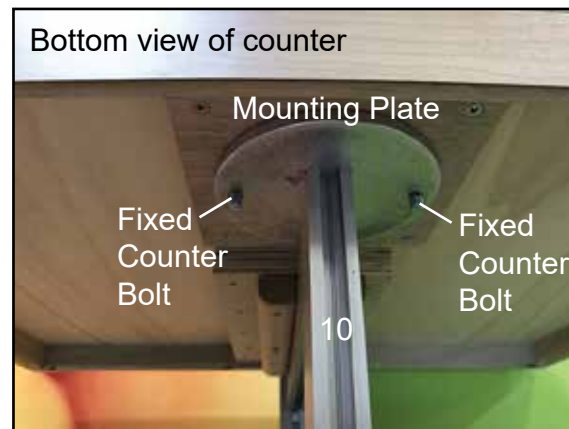

4) Place fixed counter bolts into mounting plate, then lift counter to re-tighten bolt.

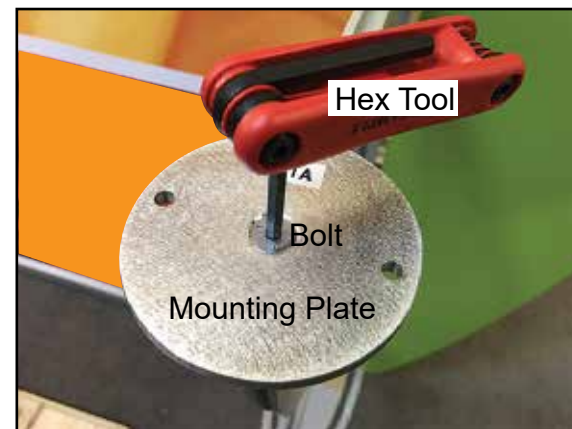

5) Tighten bolt, using hex tool, to secure.



6) Place fixed counter bolts into mounting plate, then secure using wing nuts.

Completed Assembly

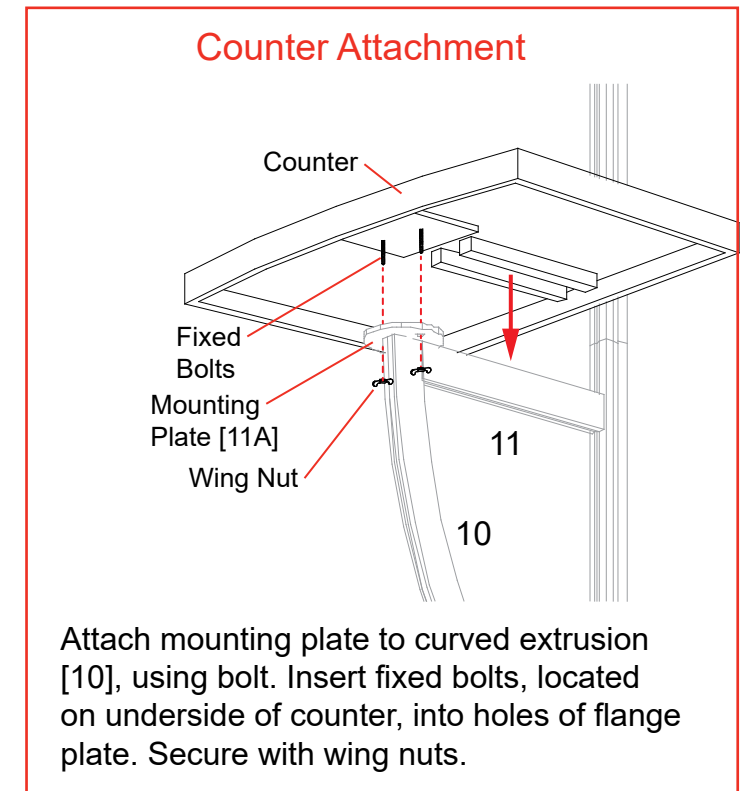

Keep mounting plate [11A] and wing nuts attached to counter, when packing.

Keep bolt attached to [10], when packing.

### Top View of Each Level

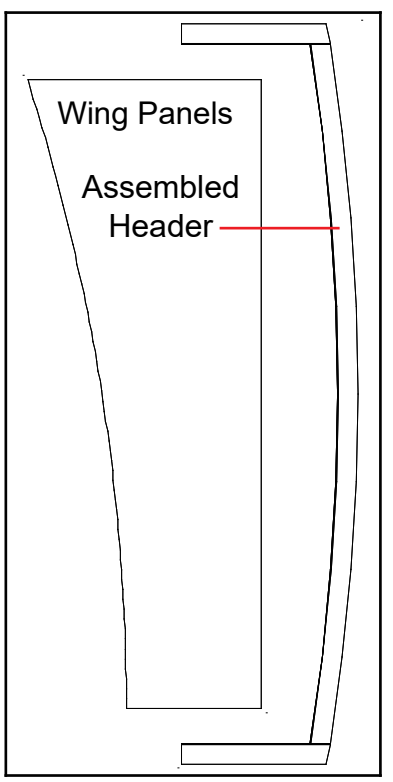

Level 1 (Bottom Level)

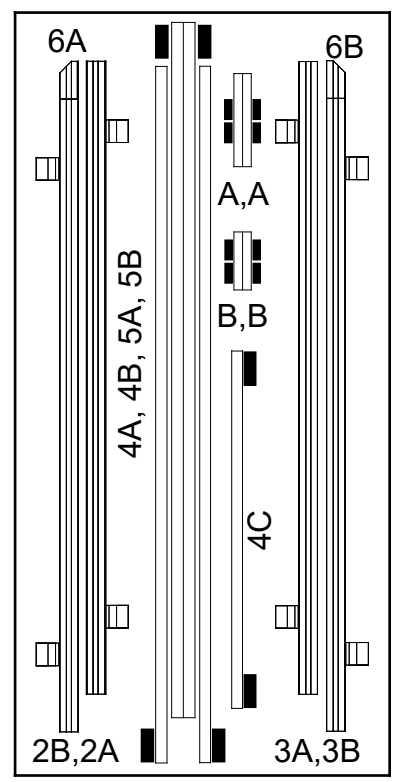

Level 2

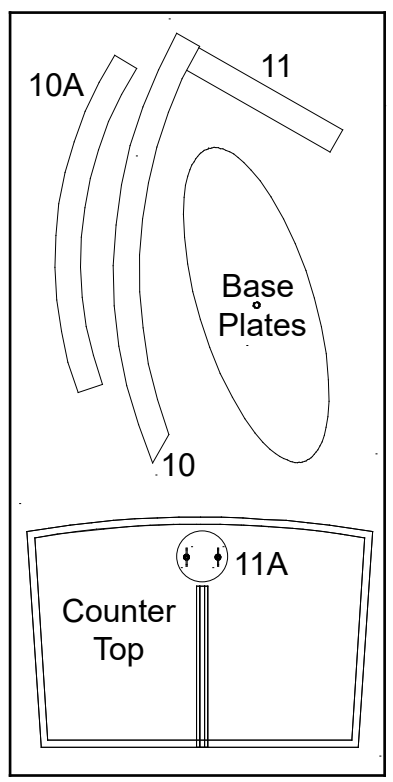

Level 3

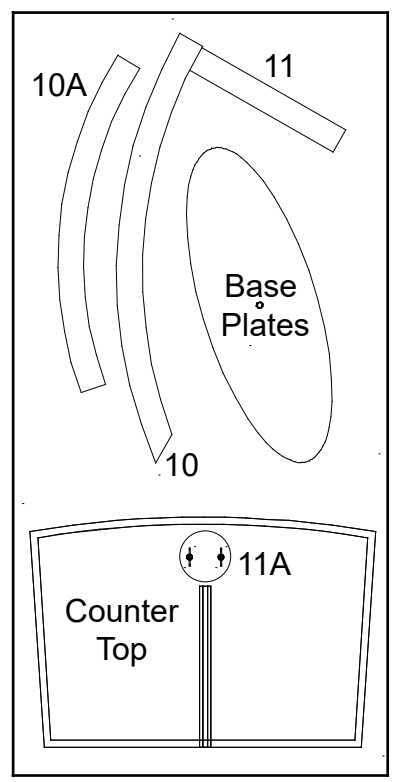

Level 4

Lights

Graphics

Setup Hardware  
Shelf

### Top View of Each Level

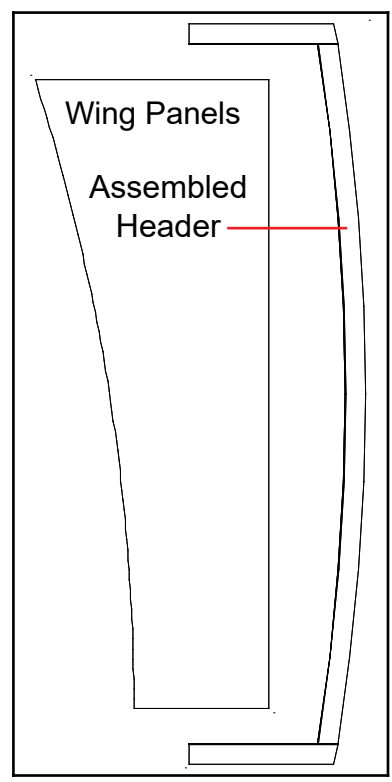

Level 1 (Bottom Level)

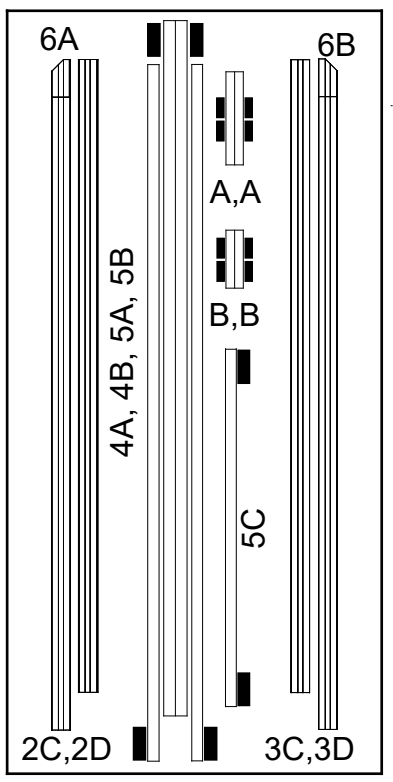

Level 2

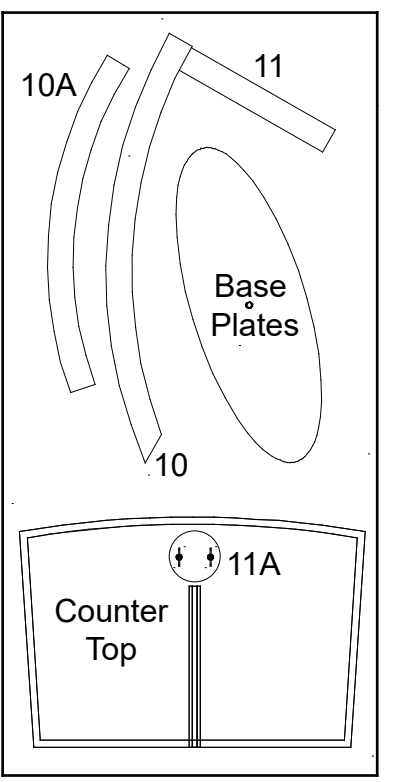

Level 3

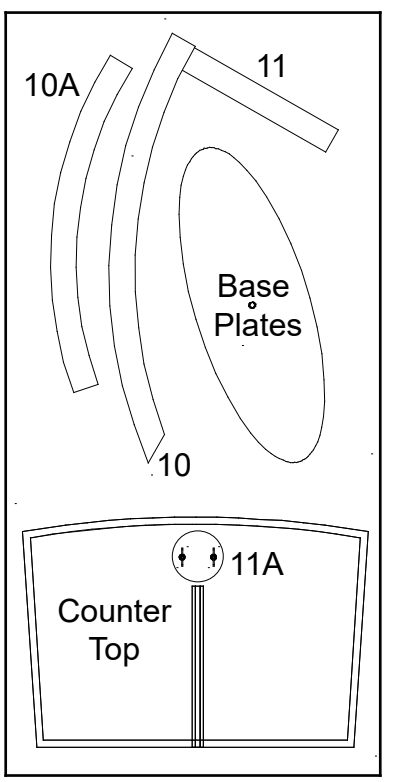

Level 4

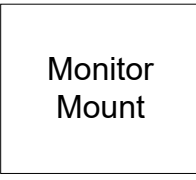
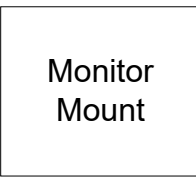



Item	Qty.	Description
1	2	Base Plate
2A,2B	1,1	42" S40 Vertical Extrusion w/ A10 Clamps
3A,3B	1,1	42" S40 Vertical Extrusion w/ A10 Clamps
2C,2D	1,1	42" S40 Vertical Extrusion
3C,3D	1,1	42" S40 Vertical Extrusion
4A,4B	2,2	45" Z45 Horizontal Extrusion
5A,5B	2,2	45" Z45 Horizontal Extrusion
4C,5C	1,1	24" Z45 Horizontal Extrusion
6A,6B	2,2	2.5" S40 Angle-Cut Vertical

- Steps:
- 1) Attach base plates [1] lower verticals [2A] [3A] [2C] and [3C], using bolts.
  - 2) Connect verticals [2A to 2B] [2C to 2D], [3A to 3B] and [3C to 3D], using connection bars [B]. See [Straight Connection with Knobs](#) detail.
  - 3) Connect horizontals [4A to 4B] and [5A to 5B], using connection bars [A]. See [Straight Connection with Knobs](#) detail.
  - 4) Attach vertical assemblies [2A/2B] [3A/3B] [2C/2D] and [3C/3D] with horizontal assemblies [4A/4B] and [5A/5B]. See [Corner Connection with Knob](#) detail.
  - 5) Connect extrusions [6A] and [6B] to verticals [2B] [2D] [3B] and [3D]. See [2.5" h Angle-Cut Vertical Attachment](#) detail.
  - 6) Connect left & right assemblies using horizontals [4C,5C].
  - 7) Attach graphic to Velcro on back of assembled Backwall.

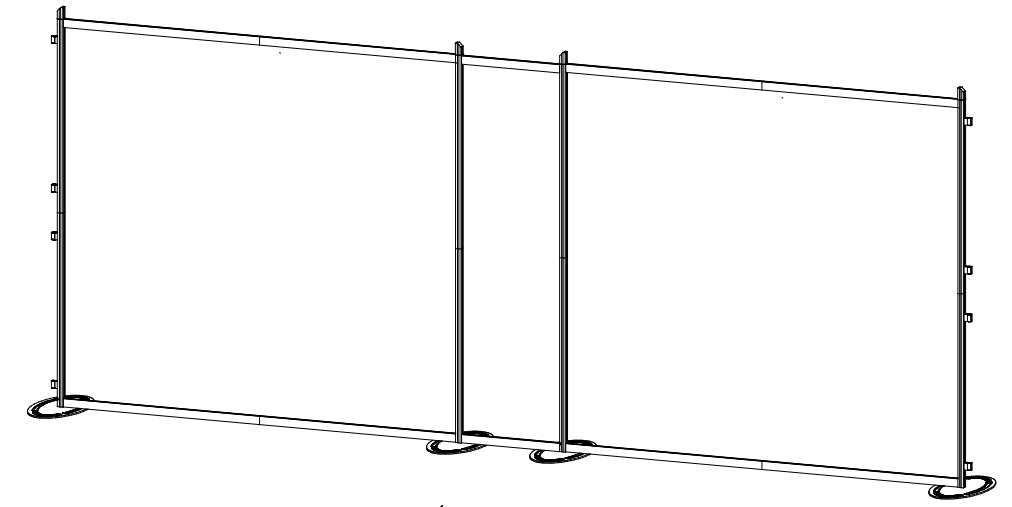

When Assembled

★ **Corner Connection with Knob**



Turn knob clockwise to tighten lock.

Do not over tighten Knobs

◆ **Straight Connection with Knobs**

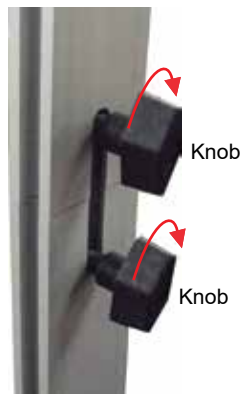

Slide connection bar between extrusions, then turn knobs clockwise to tighten lock.

Do not over tighten Knobs

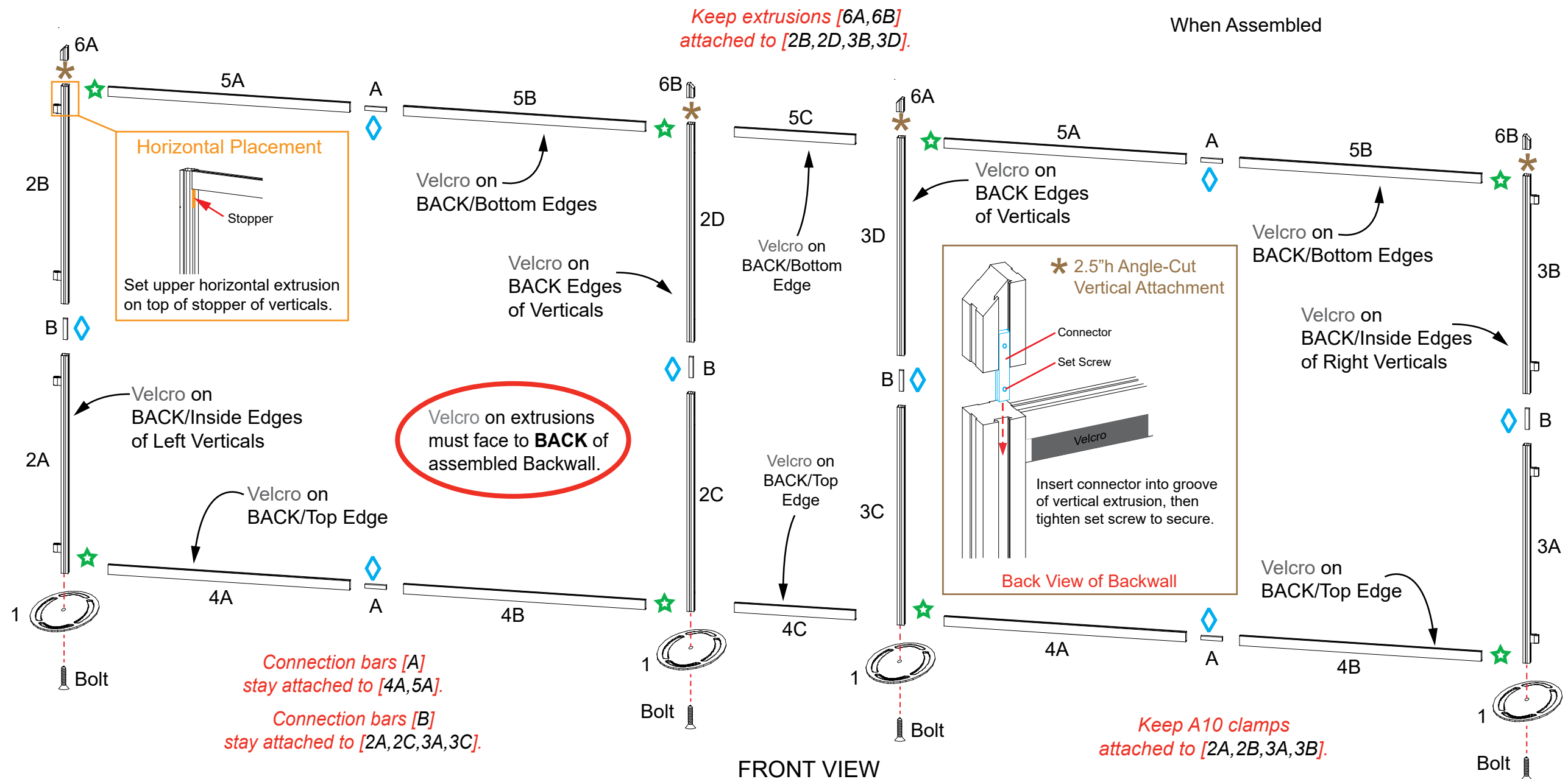

Steps:

- 1) Connect lights to top horizontal extrusions. See **Light Connection** detail.
- 2) Attach assembled Header Frames and affix graphics using Velcro.
- 3) Attach extrusions [10/11] to verticals [2A], [2C], [3C] & [3A]; connect shelf to vertical [2A].
- 4) Attach support legs [10A] to curved extrusions [10].
- 5) Attach flange plates [11A] to top of curved extrusions [10], using bolts.
- 6) Attach counter tops to counter mounting plates [11A]. See Counter Assembly page.
- 7) Attach Wings to A10 clamps. See **Clamp Attachment** detail.
- 8) Attach Monitor Mounts to verticals [2B] & [3B]. See **Monitor Mount Attachment** detail.

Item	Qty.	Description
7/8/9	2/2/2	Header Frame
10	4	30.2" Curved Extrusion
10A	4	Support Leg
11	4	12.184" Horizontal Extrusion
11A	4	Counter Mounting Plate

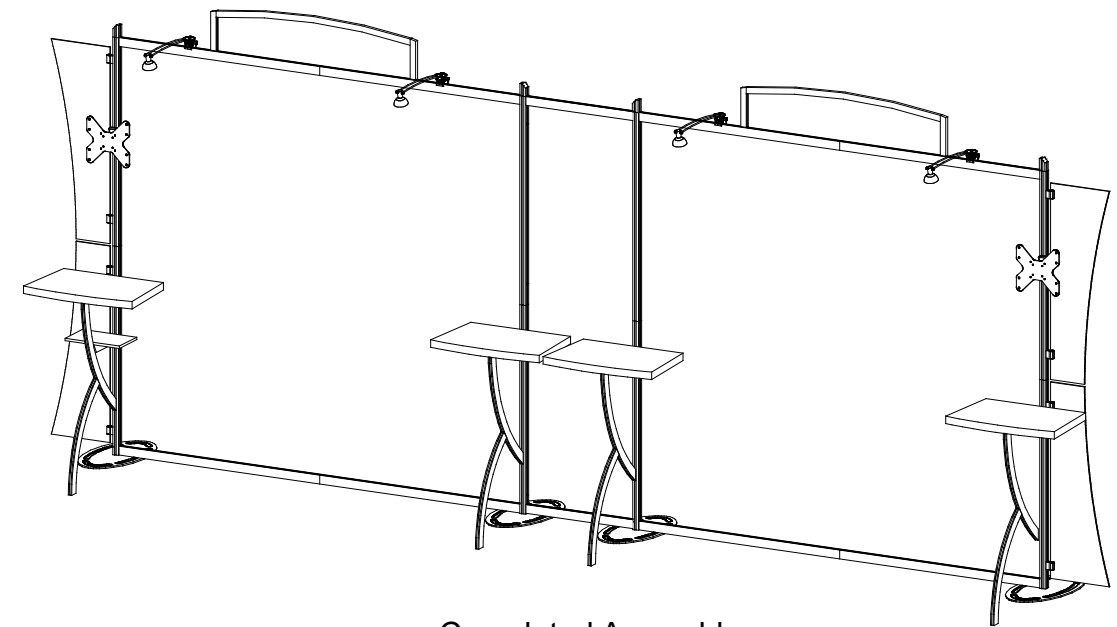

Completed Assembly

\* Monitor Mount Attachment

Slide V4 Connectors into groove of Extrusion. Tighten Set Screws to secure connectors in place.

Attach Monitor Mount back piece to Extrusion, using bolts.

Then slide monitor mount into back piece.

\* Light Connection

Slide light onto clip then lock clip into groove of horizontal extrusion.

