

Front View

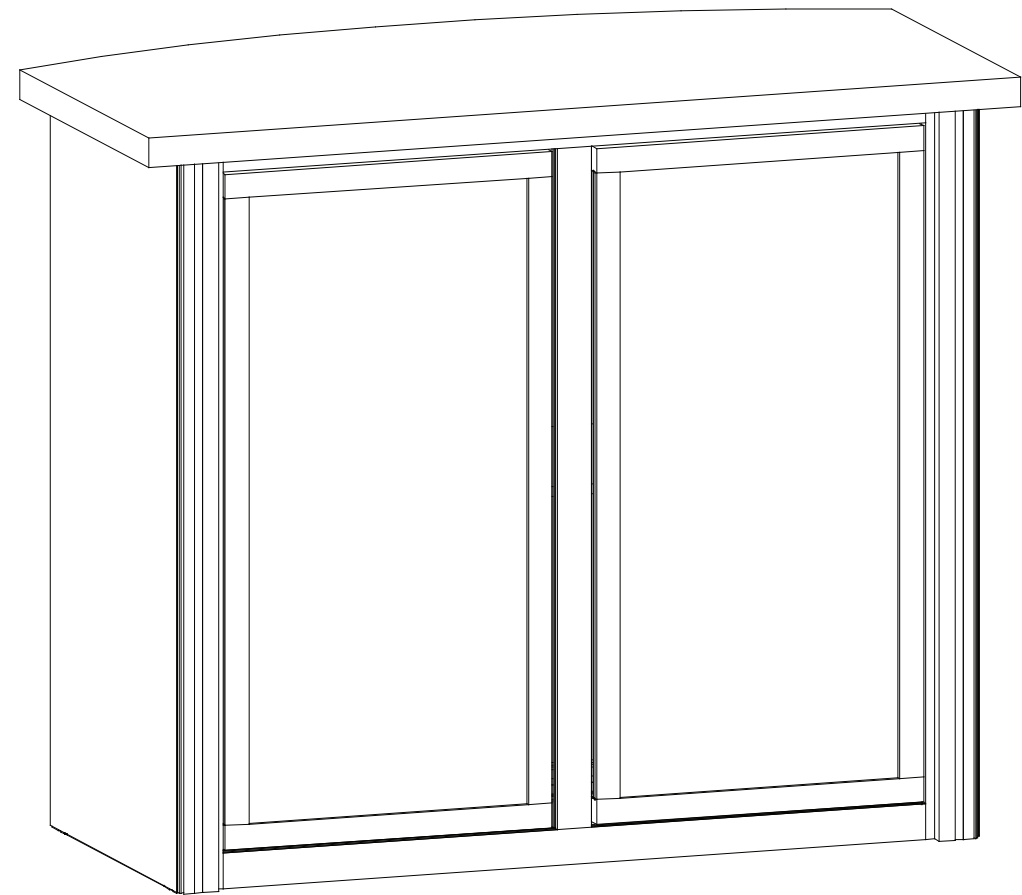

Back View

SETUP INSTRUCTIONS

General Setup Instructions

- Read entire setup instruction manual prior to unpacking parts and pieces.
- The setup instructions are created specifically for this configuration.
- Setup instructions are laid out sequentially in steps, including exploded views with detailed explanation for assembly.

Cleaning & Packing

- For Cleaning Metal, Plex, & Laminate Parts: Use a **MILD NON-ABRASIVE** cleanser and soft cloth/paper towel to clean all surfaces.
- Keep exhibit components away from heat and prolonged sun exposure. **Heat and UV exposure will warp and fade components.**
- Retain all provided Packing Materials. All provided packing materials are for ease of repacking & component protection.

Disassembly

- For loss prevention, tighten all set screws and locks during disassembly.

Assembly

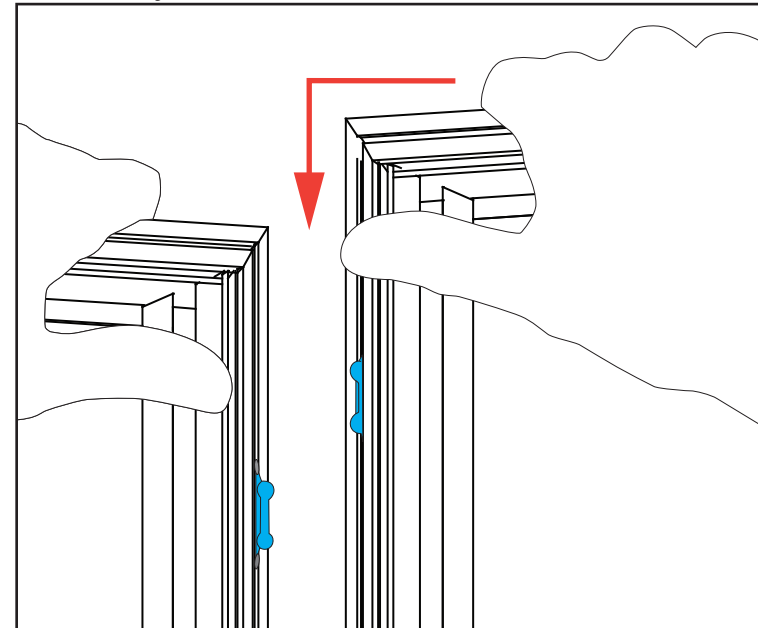

Side-by-Side Assembly

- 1) Frames: Place frames side-by-side with one higher than the other, then slide panel down to lock panels securely together.
- 2) Corner Connectors: Repeat Step 1 for installing corner connectors to frames.

Assembly Cont'd

Push pin lock into hole of connecting frame.
Note: Block on pin lock will secure in groove.

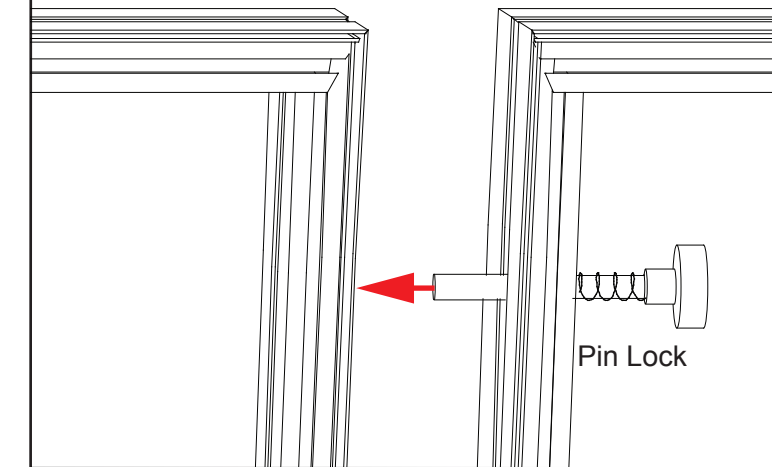

Side-by-Side Disassembly

- 1) Pull pin lock outwards to disengage.
- 2) Pull frames upward and apart at the same time to detach.

SEG Graphic Installation in 3 Steps

The Perfect Fit

STEP 1: Attach Corners

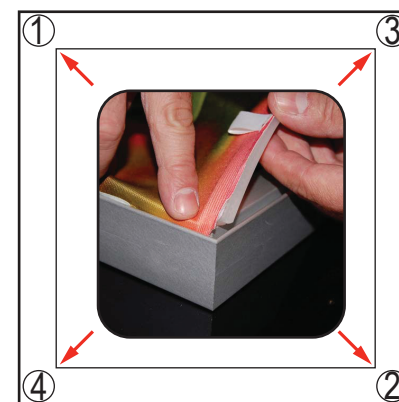

Always insert graphic into each alternate corner, then into the sides of the frame. Otherwise the graphic will not fit into the frame correctly.

Insert narrow side of silicone welt into the channel at corner 1, with fabric to the outside. Repeat for opposite corner 2, then corner 3, then corner 4.

STEP 2: Attach Middle

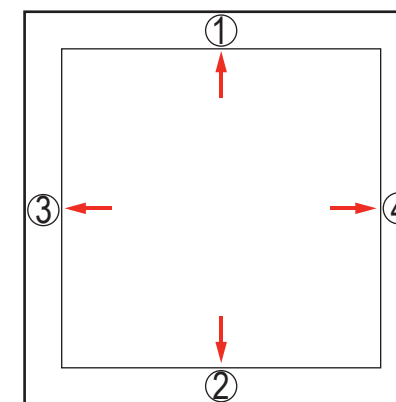

Once corners are attached, press the middle of edge 1 into the channel. Then press middle of edge 2 into the channel on opposite side. Repeat with edge 3 & 4.

STEP 3: Attach Sides

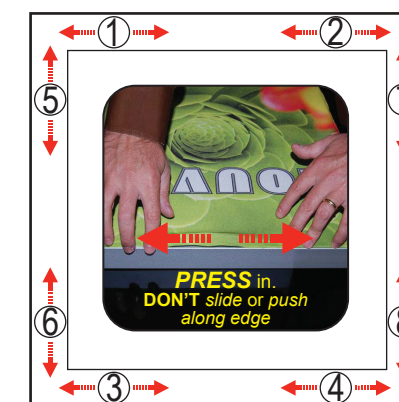

Once the middle of sides are attached, fully press the silicone welt into the channel, between center and corner at location 1. Repeat the process between center and corner at location 2.

Do the same for welt on opposite side, at locations 3 & 4. Then repeat for locations 5 & 6 and 7 & 8.

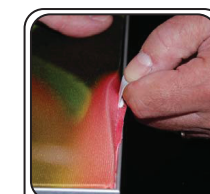

To remove graphic from the frame, locate the fabric pull tab. Gently pull on the tab to remove the graphic.

Install video:



Item	Qty.	Description
1	1	38"h Gravitee Corner Post w/ Door Attachment
2	1	14.125"w x 38"h Gravitee Panel Frame
3	1	38"h Gravitee Corner Post
4	1	19"w x 38"h Gravitee Panel Frame
5	1	19"w x 38"h Gravitee Panel Frame
6	1	38"h Gravitee Corner Post
7	1	14.125"w x 38"h Gravitee Panel Frame
8	1	38"h Gravitee Corner Post w/ Door Attachment
9,9A	1,1	37.0945"w Z45 Horizontal Extrusion
10	1	34.4173"h Z45 Vertical Extrusion

Steps:

- 1) Assemble Gravitee panels and posts in numerical order, as shown, making sure Velcro is facing inward. See Gravitee Panel Assembly sheet, for instruction.
- 2) Attach horizontal extrusions [9] and [9A] between posts [2] and [7].
- 3) Attach vertical [10] between horizontals [9] and [9A].
- 4) Connect doors to posts [1] and [8]. See **Door Connection** detail.

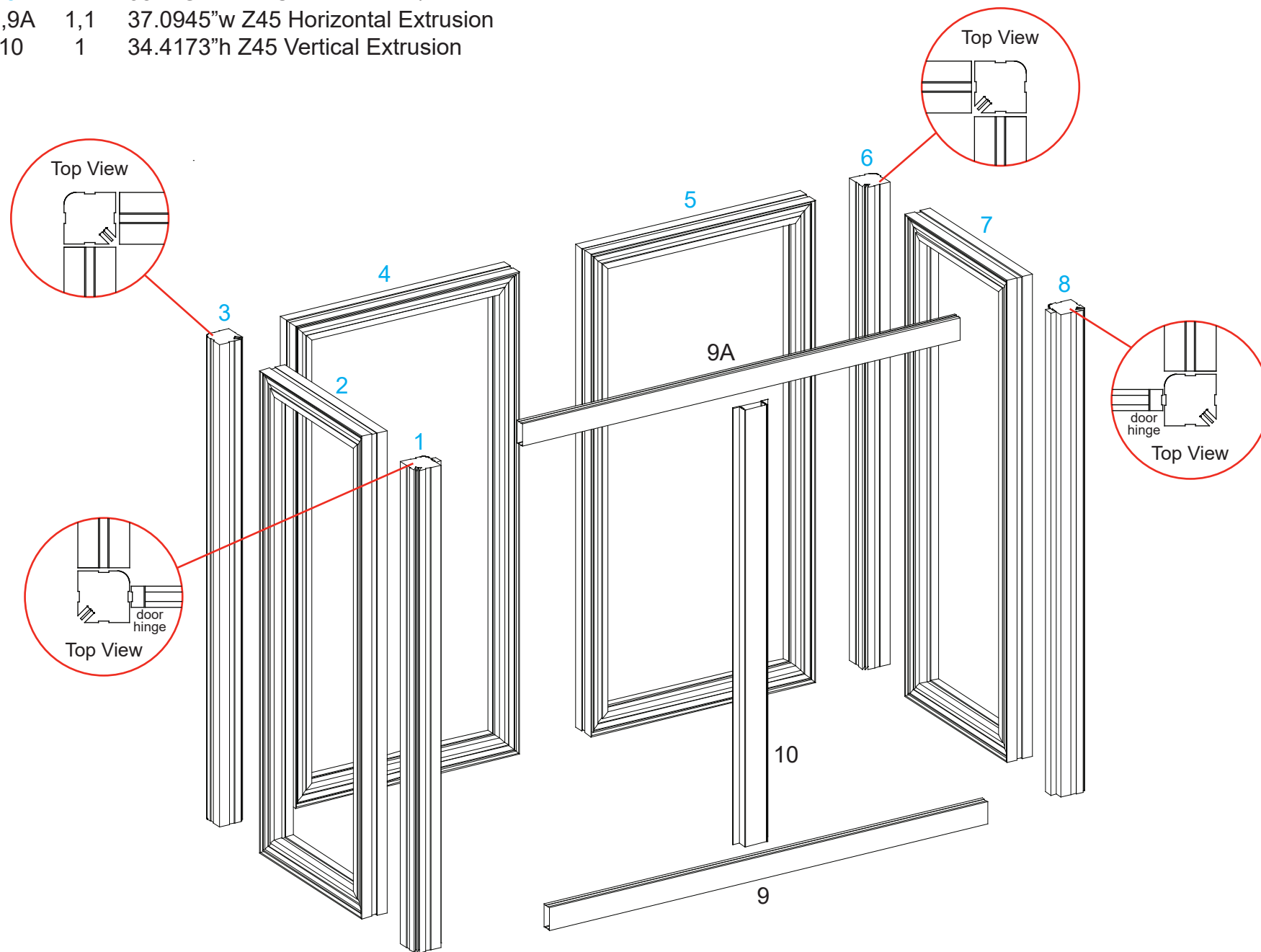
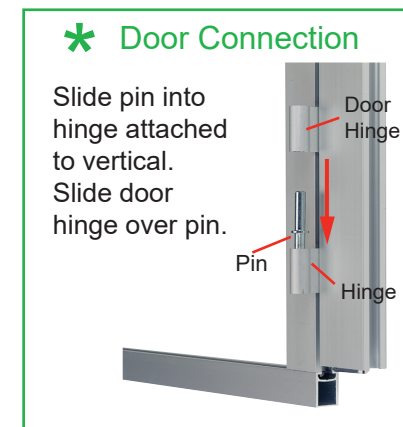

Back View

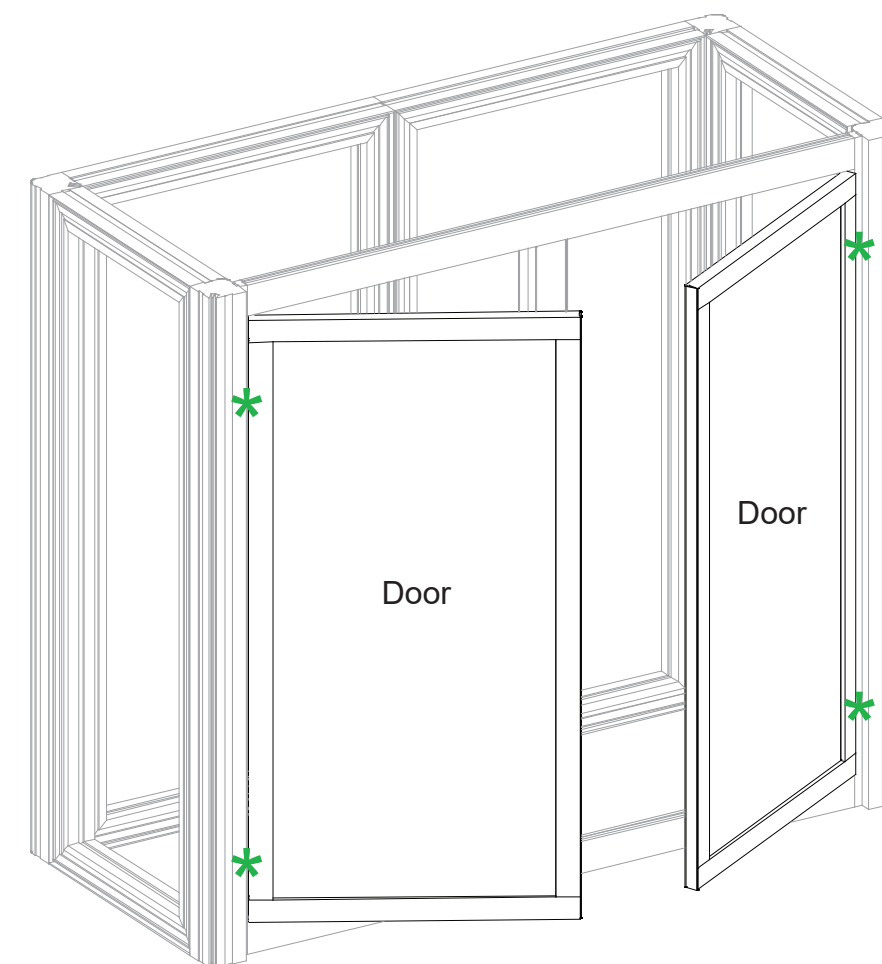

Back View

Steps:

- 1) Wrap **SEG Graphic** around front and sides of assembled counter.
- See SEG Graphic Installation sheet for instruction.
- 2) Connect shelf supports to Velcro, then place shelf on top of supports.
- 3) Lock counter top to panels [2] and [7]. See **Counter Top Lock** detail.

Keep connectors [1] [8] extrusions [9] [9A] [10] and doors assembled, when packing.

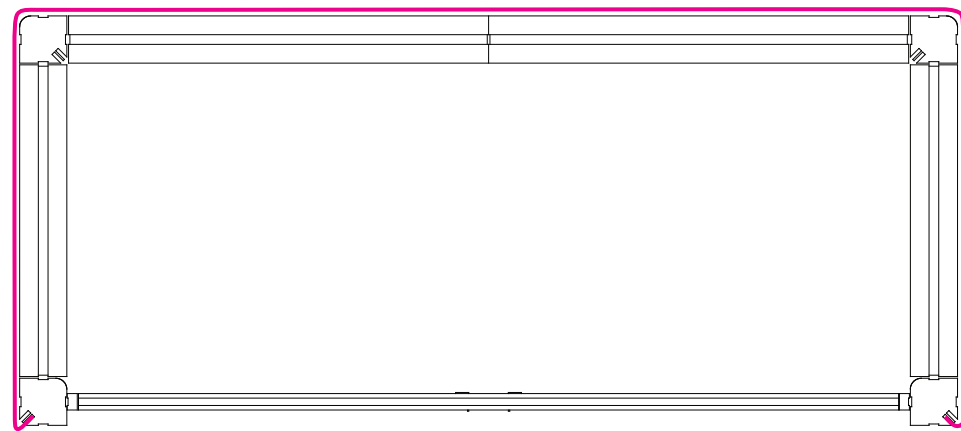

Top View

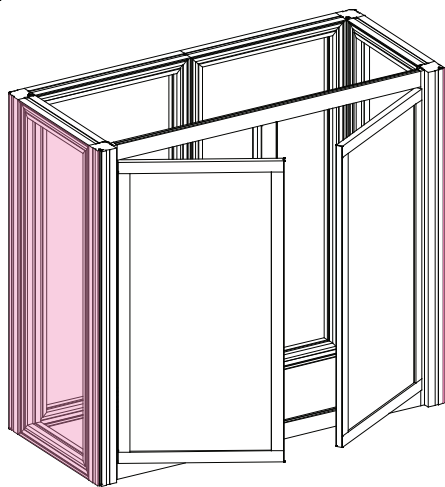

Back View

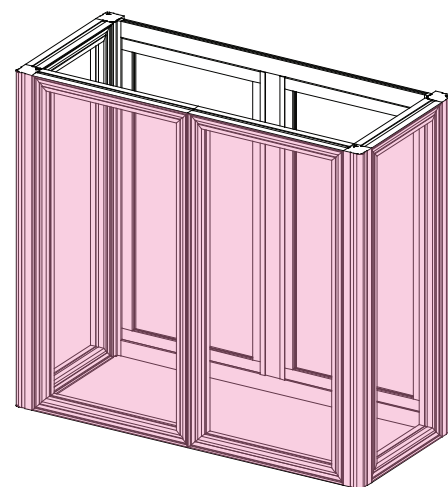

Front View

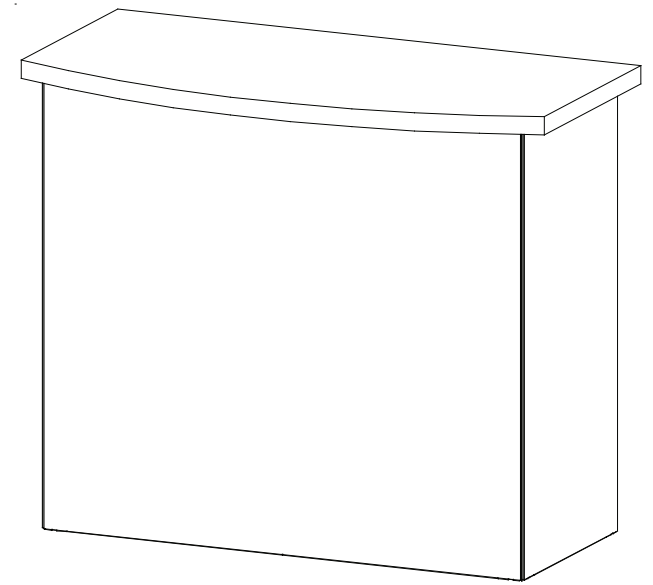
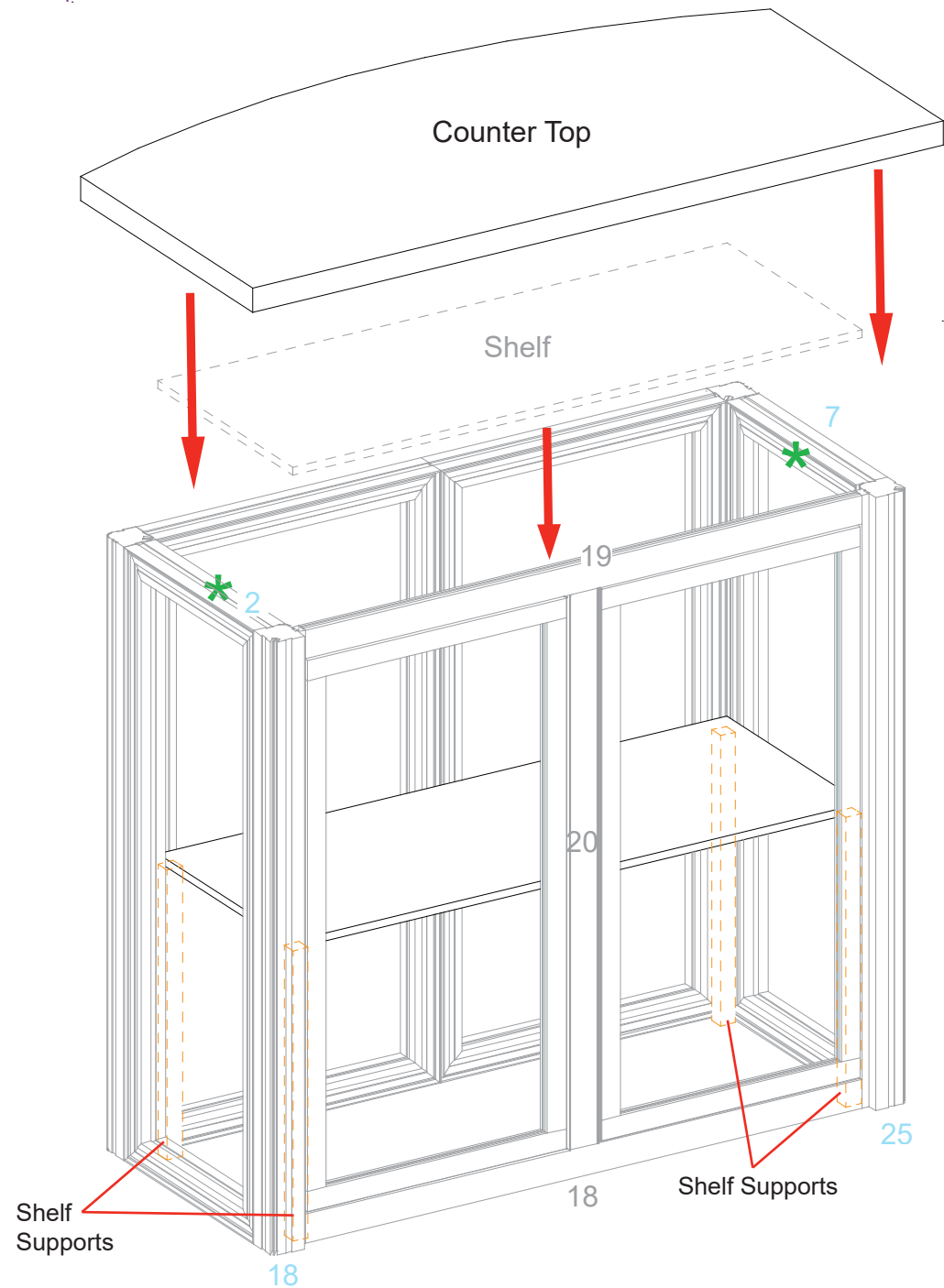

Completed Assembly

